

Quick Setup Guide/Guia de Instalação Rápida

DAV-DZ380W/DZ680W/DZ880W

For details, see the Operating Instructions.
Para mais detalhes, consulte o Manual de Instruções.

1 Connecting the speakers/Ligar as colunas

2 Connecting the TV/Ligar o televisor

Connect the speaker cords to match the color of the SPEAKER jacks of the unit.

Ligue os cabos das colunas de acordo com a cor das tomadas SPEAKER da unidade.

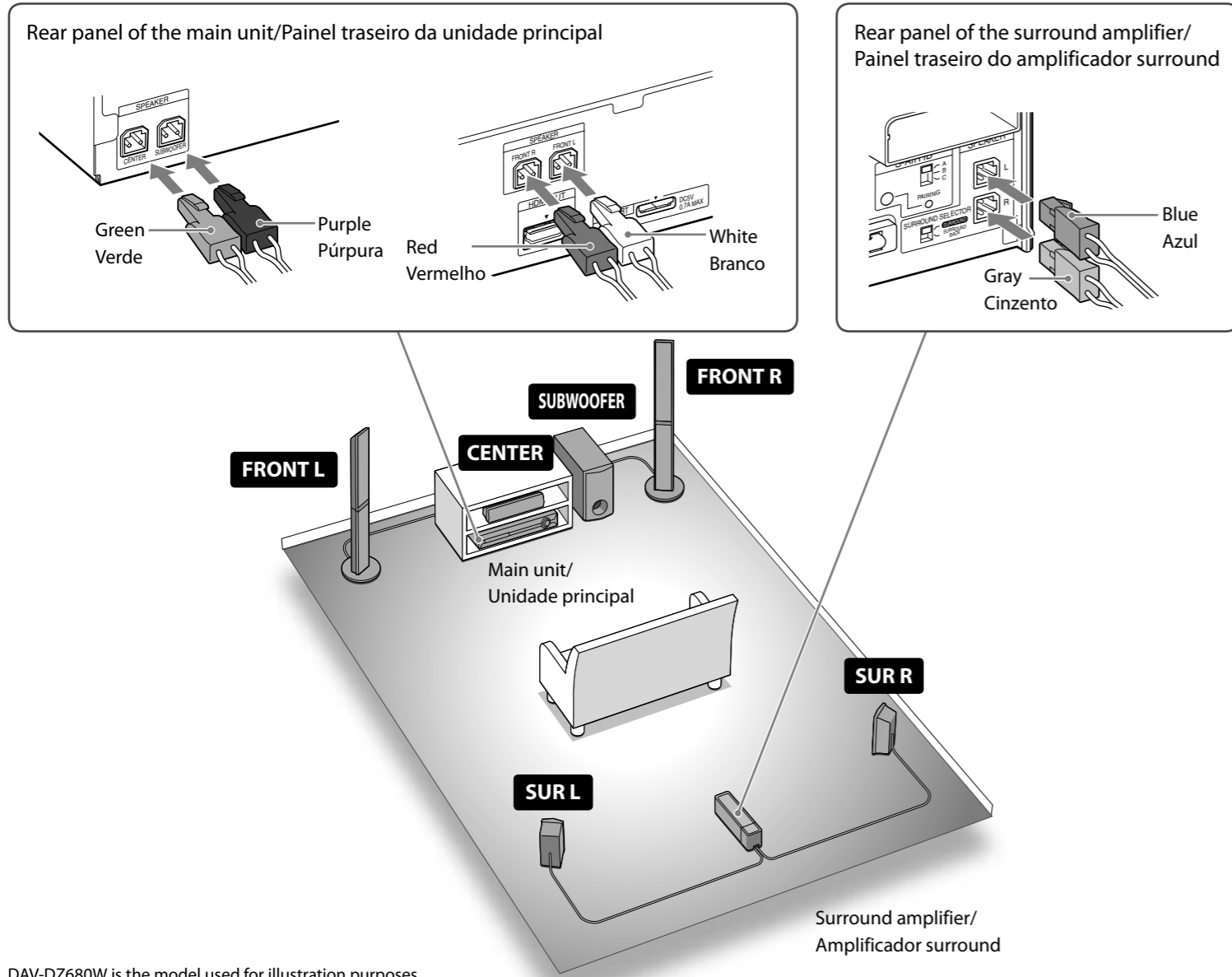

DAV-DZ680W is the model used for illustration purposes.
DAV-DZ680W é o modelo utilizado para fins ilustrativos.

To connect speaker cords to the speaker/Ligar os cabos das colunas às colunas

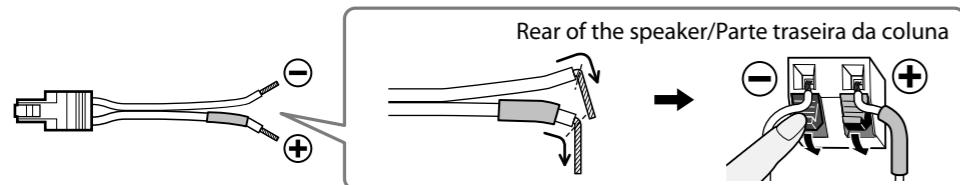

Depending on the jacks on your TV, select the video and audio connection method.

Dependendo das tomadas do seu televisor, seleccione o método de ligação vídeo e áudio.

Video connection method/Método de ligação vídeo

Method 1/Método 1

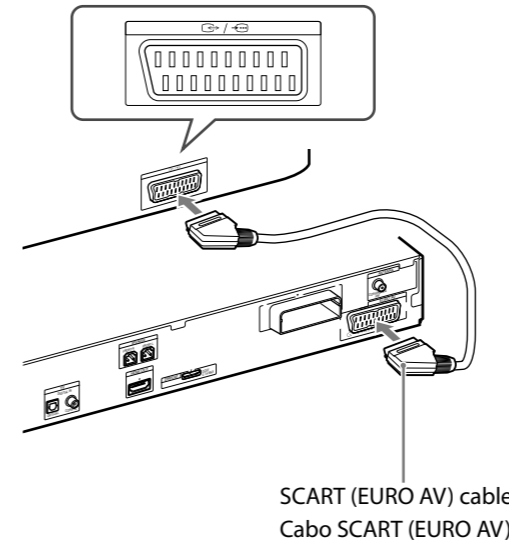

Method 2/Método 2

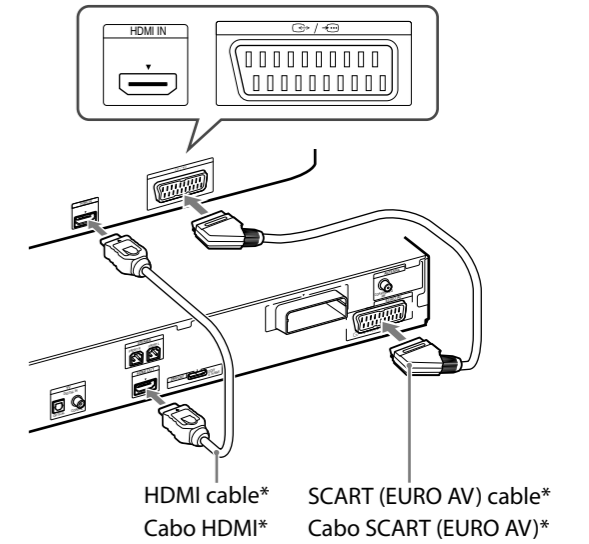

*Not supplied/Não fornecido

Audio connection method/Método de ligação áudio

Method 1/Método 1

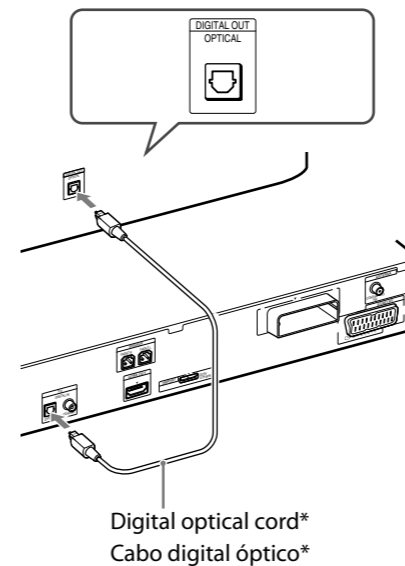

Method 2/Método 2

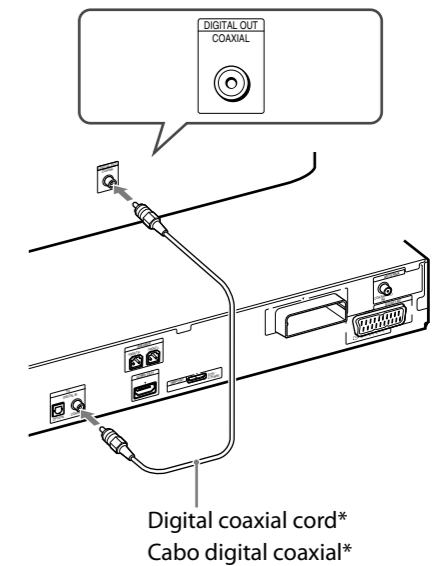

*Not supplied/Não fornecido

3 Enabling wireless transmission/ Activar a transmissão sem fios

- 1 Insert the wireless transceiver.
Insira o transmissor-receptor sem fios.**

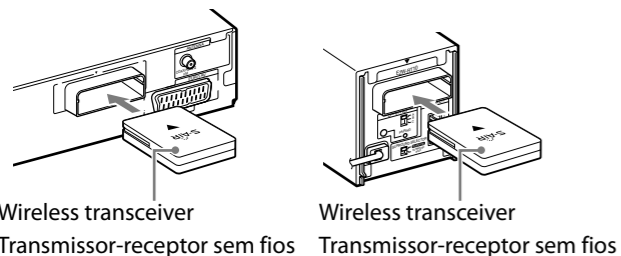

- 2 Set the S-AIR ID switch to "A."
Regule o interruptor S-AIR ID para "A."**

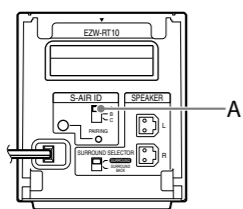

- 3 Connect the AC power cord.
Ligue o cabo de alimentação CA.**

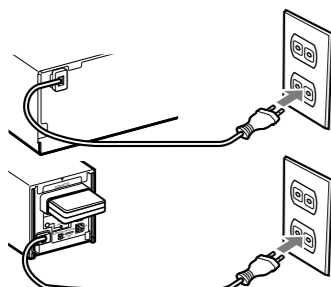

- 4 Turn on the power of the main unit, the surround amplifier, and the TV.
Ligue a alimentação da unidade principal, o amplificador surround e o televisor.**

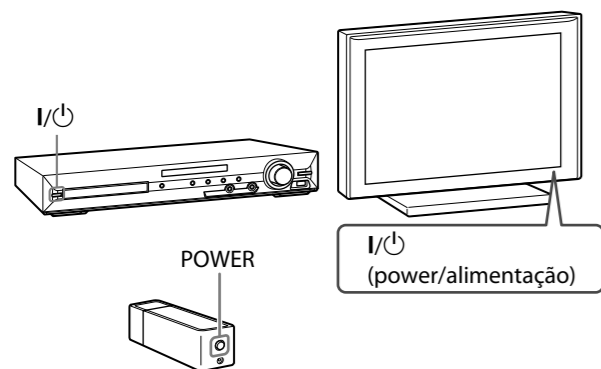

4 Performing the Quick Setup/Realização da Instalação rápida

Note
Do not insert a disc before performing the Quick Setup.
Nota
Não introduza um disco antes de realizar a Instalação Rápida.

- 1 Switch the input selector on your TV to display "SONY Home Theatre System."
Regule o selector de entrada do televisor de modo a ser exibido "SONY Home Theatre System."**

- 2 Set each following item, using $\leftarrow/\rightarrow/\uparrow/\downarrow$ and \oplus .
Configure cada um dos seguintes itens utilizando $\leftarrow/\rightarrow/\uparrow/\downarrow$ e \oplus .**

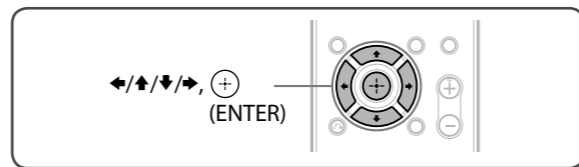

Note
Displayed items vary depending on the area.

Nota
Os itens apresentados variam consoante a região.

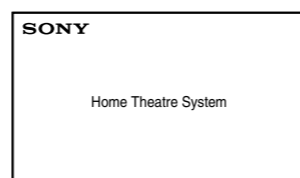

Select an on-screen language.
Selecione um idioma de visualização no ecrã.

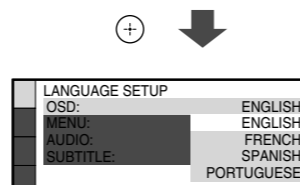

Select the aspect ratio of the connected TV.
Selecione o formato do televisor ligado.

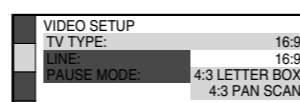

Select the output method for video signals.
Selecione o método de saída para sinais de vídeo.

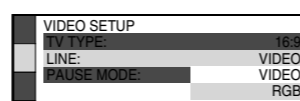

Select [ON] when you connect the main unit and the TV with an HDMI cable.
Selecione [ACTIVADO] quando ligar a unidade principal e o televisor com um cabo HDMI.

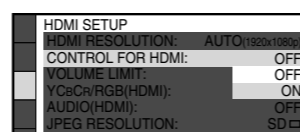

Select the speaker formation.
Selecione a formação das colunas.

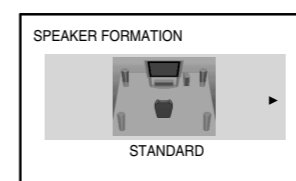

Connect the calibration mic and set it at the listening position.
Ligue o microfone de calibragem e regule-o para a posição e audição.

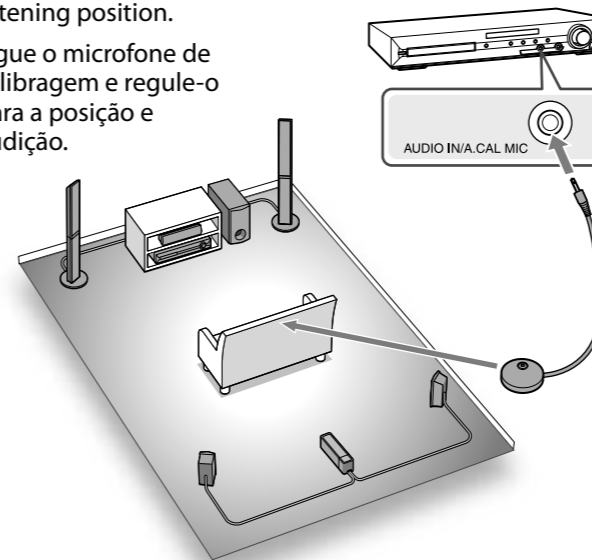

Select [YES] to perform [AUTO CALIBRATION].
Selecione [SIM] para realizar [CALIBRAGEM AUTO].

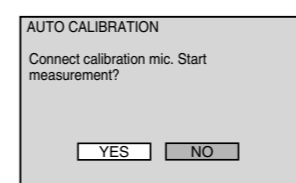

Select [YES] to save the measurement results.
Selecione [SIM] para guardar os resultados da medição.

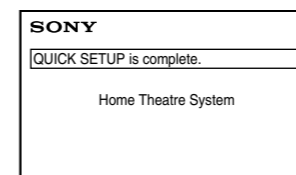
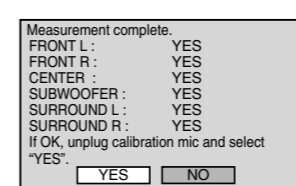

Listening to TV sound from all speakers/
Ouvir som do televisor a partir de todas as colunas

- 1 Press FUNCTION +/- to display "TV."
Prima FUNCTION +/- para apresentar "TV."**

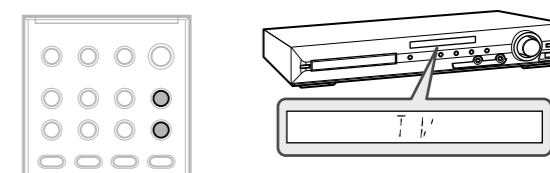

- 2 Press SYSTEM MENU.
Prima SYSTEM MENU.**

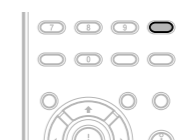

- 3 Press \uparrow/\downarrow to display "DEC. MODE," then press \oplus .
Prima \uparrow/\downarrow para apresentar "DEC. MODE," e prima \oplus .**

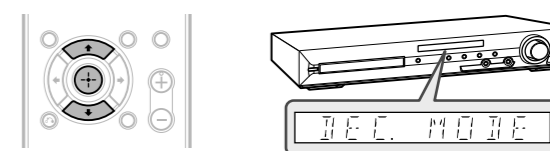

- 4 Press \uparrow/\downarrow to display "PRO LOGIC," then press \oplus .
Prima \uparrow/\downarrow para apresentar "PRO LOGIC," e prima \oplus .**

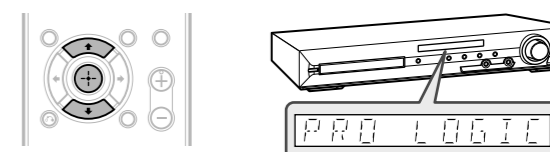

- 5 Press SYSTEM MENU to exit the menu.
Prima SYSTEM MENU para sair do menu.**

