

Quick Setup Guide/Guia de Instalação Rápida

DAV-DZ680/DZ780

For details, see the Operating Instructions.
Para mais detalhes, consulte o Manual de Instruções.

1 Connecting the speakers/Ligar as colunas

Connect the speaker cords to match the color of the **SPEAKER** jacks of the unit.
Ligue os cabos das colunas de acordo com a cor das tomadas **SPEAKER** da unidade.

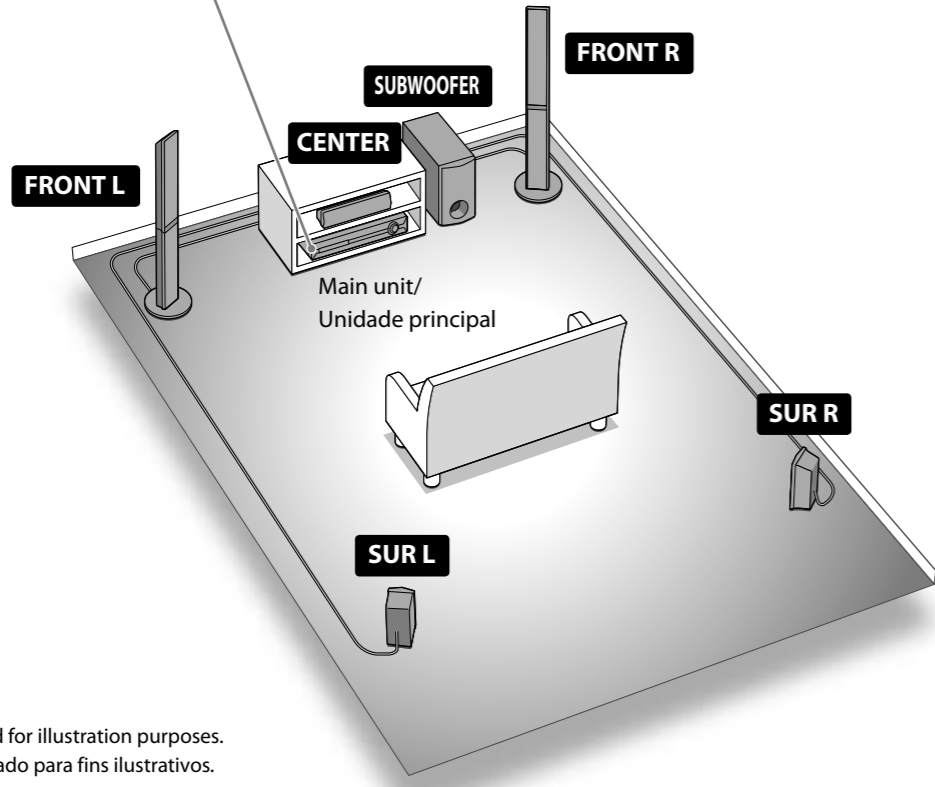
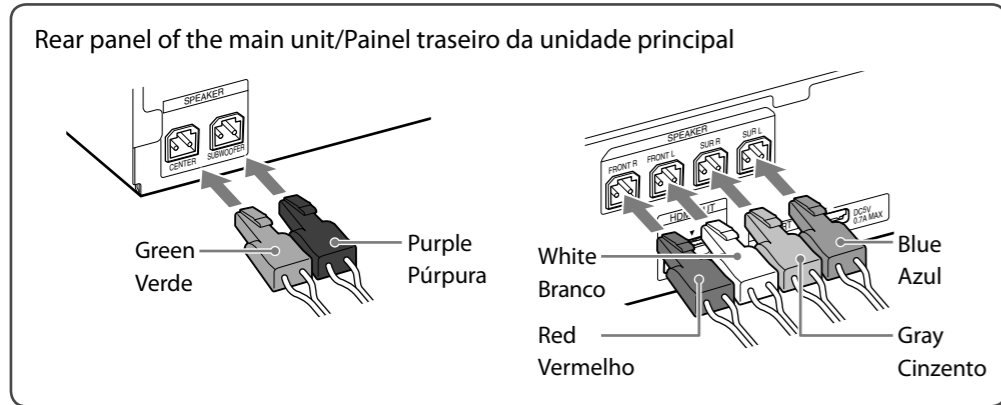

DAV-DZ680 is the model used for illustration purposes.
DAV-DZ680 é o modelo utilizado para fins ilustrativos.

To connect speaker cords to the speaker/Ligar os cabos das colunas às colunas

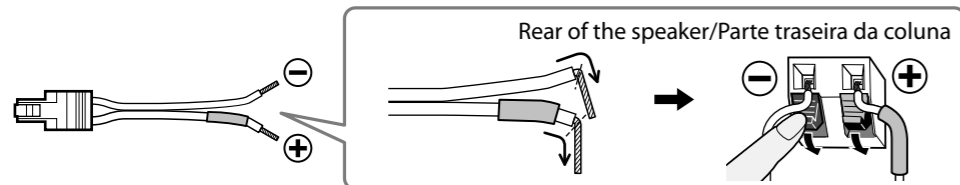

2 Connecting the TV/Ligar o televisor

Depending on the jacks on your TV, select the video and audio connection method.
Dependendo das tomadas do seu televisor, seleccione o método de ligação vídeo e áudio.

Video connection method/Método de ligação vídeo

Method 1/Método 1

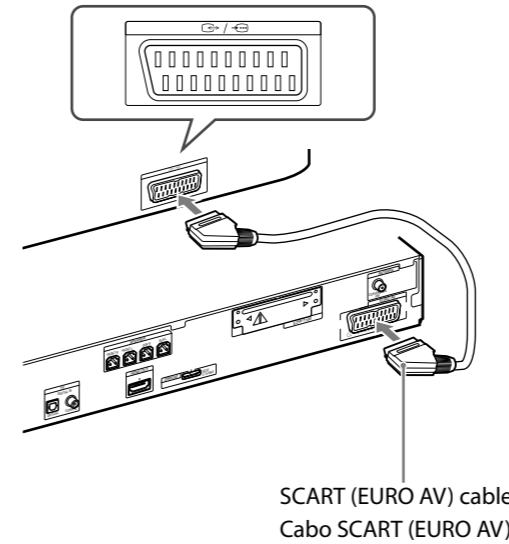

Method 2/Método 2

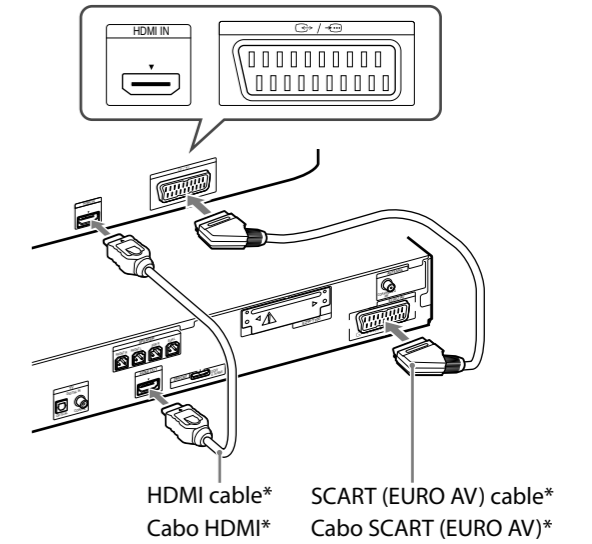

*Not supplied/Não fornecido

Audio connection method/Método de ligação áudio

Method 1/Método 1

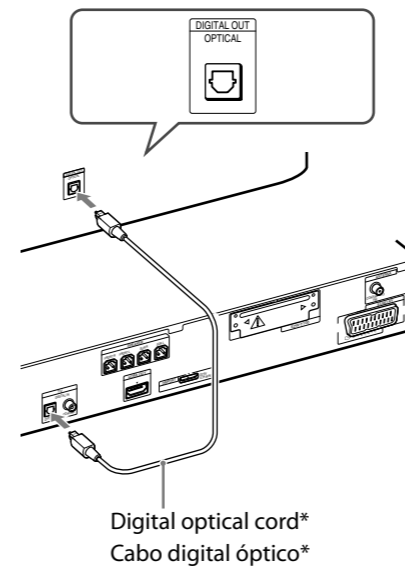

Method 2/Método 2

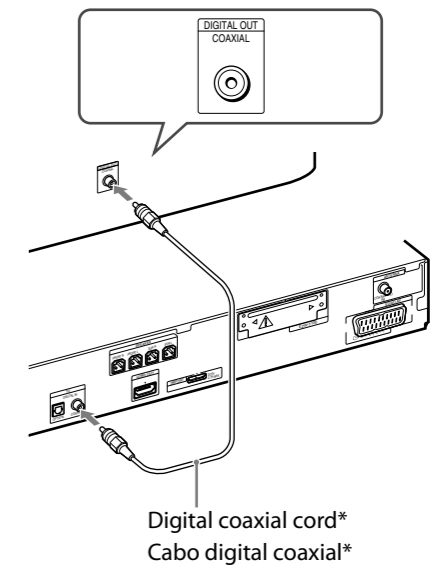

*Not supplied/Não fornecido

3 Performing the Quick Setup/Realização da Instalação rápida

Note
Do not insert a disc before performing the Quick Setup.

Nota
Não introduza um disco antes de realizar a Instalação Rápida.

- 1 Connect the AC power cord.**
The shape of the wall outlet differs depending on the area.
Ligue o cabo de alimentação CA.
O formato da tomada de parede pode variar consoante a região.

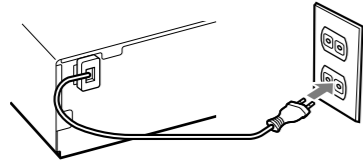

- 2 Turn on the power of the main unit and TV.**
Ligue a alimentação da unidade principal e a televisão.

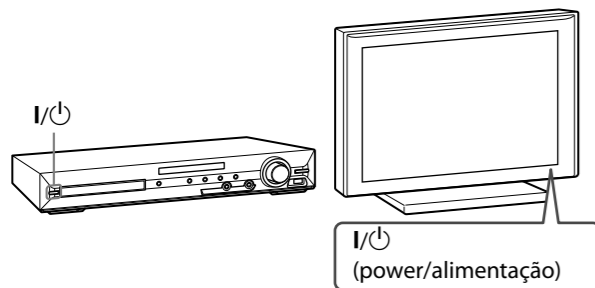

- 3 Switch the input selector on your TV to display "SONY Home Theatre System."**
Regule o selector de entrada do televisor de modo a ser exibido "SONY Home Theatre System."

- 4 Set each following item, using ←/↑/↓/→ and +.**
Configure cada um dos seguintes itens utilizando ←/↑/↓/→ e +.

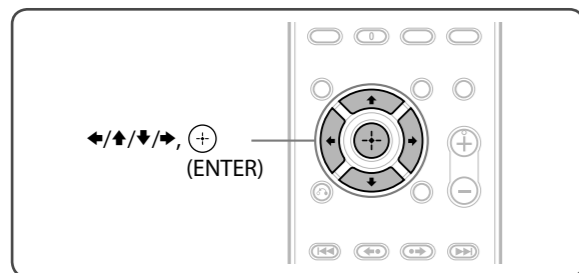

Note
Displayed items vary depending on the area.

Nota
Os itens apresentados variam consoante a região.

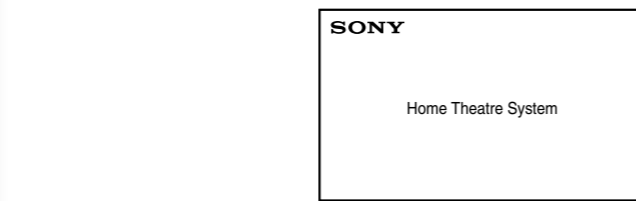

Select an on-screen language.
Selecione um idioma de visualização no ecrã.

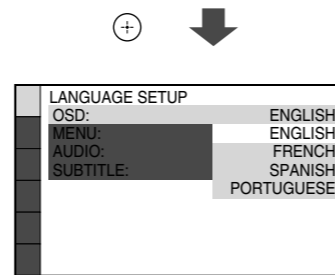

Select the aspect ratio of the connected TV.
Selecione o formato do televisor ligado.

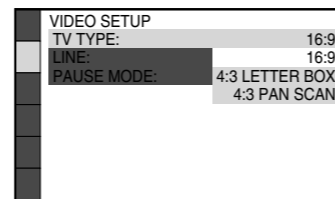

Select the output method for video signals.
Selecione o método de saída para sinais de vídeo.

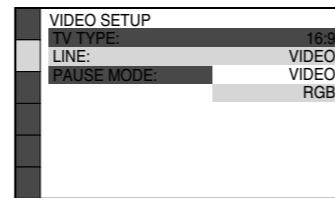

Select [ON] when you connect the main unit and the TV with an HDMI cable.
Selecione [ACTIVADO] quando ligar a unidade principal e o televisor com um cabo HDMI.

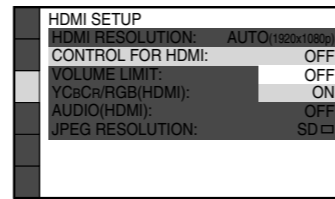

Select the speaker formation.
Selecione a formação das colunas.

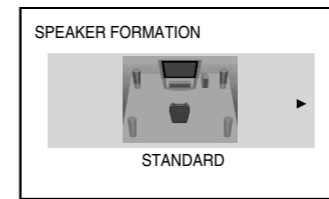

Connect the calibration mic and set it at the listening position.
Ligue o microfone de calibragem e regule-o para a posição e audição.

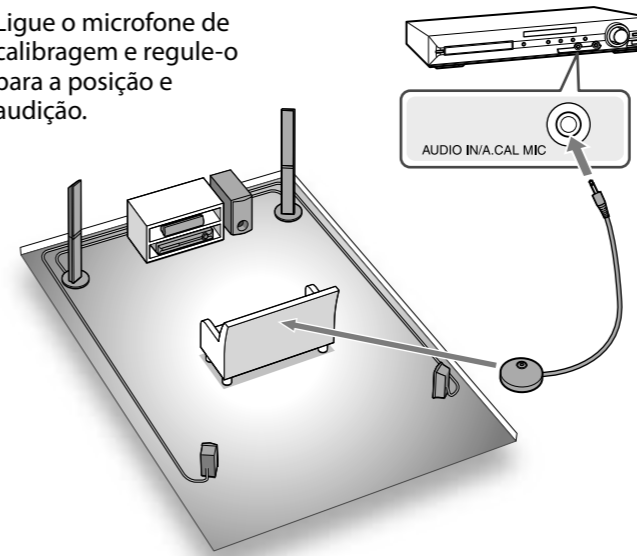

Select [YES] to perform [AUTO CALIBRATION].
Selecione [SIM] para realizar [CALIBRAGEM AUTO].

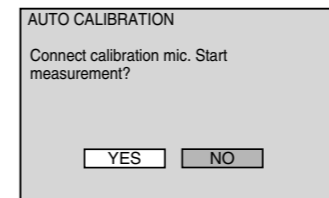

Select [YES] to save the measurement results.
Selecione [SIM] para guardar os resultados da medição.

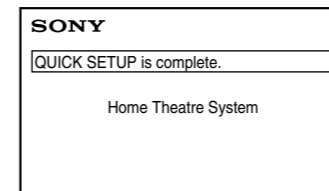
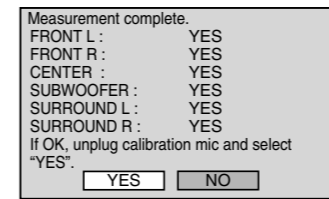

Listening to TV sound from all speakers/
Ouvir som do televisor a partir de todas as colunas

- 1 Press FUNCTION +/- to display "TV."**
Prima FUNCTION +/- para apresentar "TV".

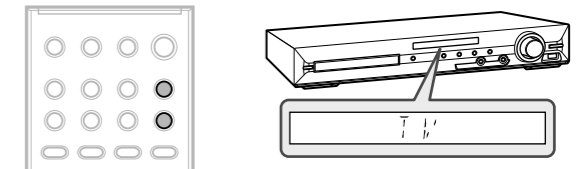

- 2 Press SYSTEM MENU.**
Prima SYSTEM MENU.

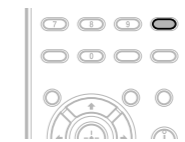

- 3 Press ↑/↓ to display "DEC. MODE," then press +.**
Prima ↑/↓ para apresentar "DEC. MODE," e prima +.

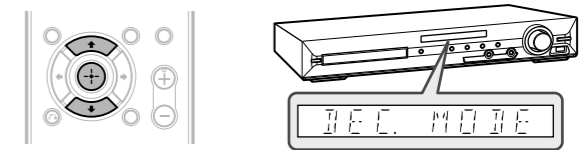

- 4 Press ↑/↓ to display "PRO LOGIC," then press +.**
Prima ↑/↓ para apresentar "PRO LOGIC," e prima +.

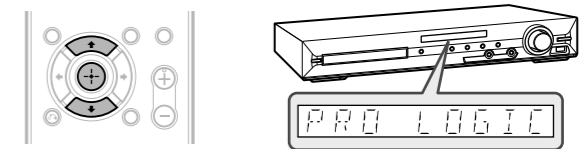

- 5 Press SYSTEM MENU to exit the menu.**
Prima SYSTEM MENU para sair do menu.

